

SPRUE TYPE (Medium)

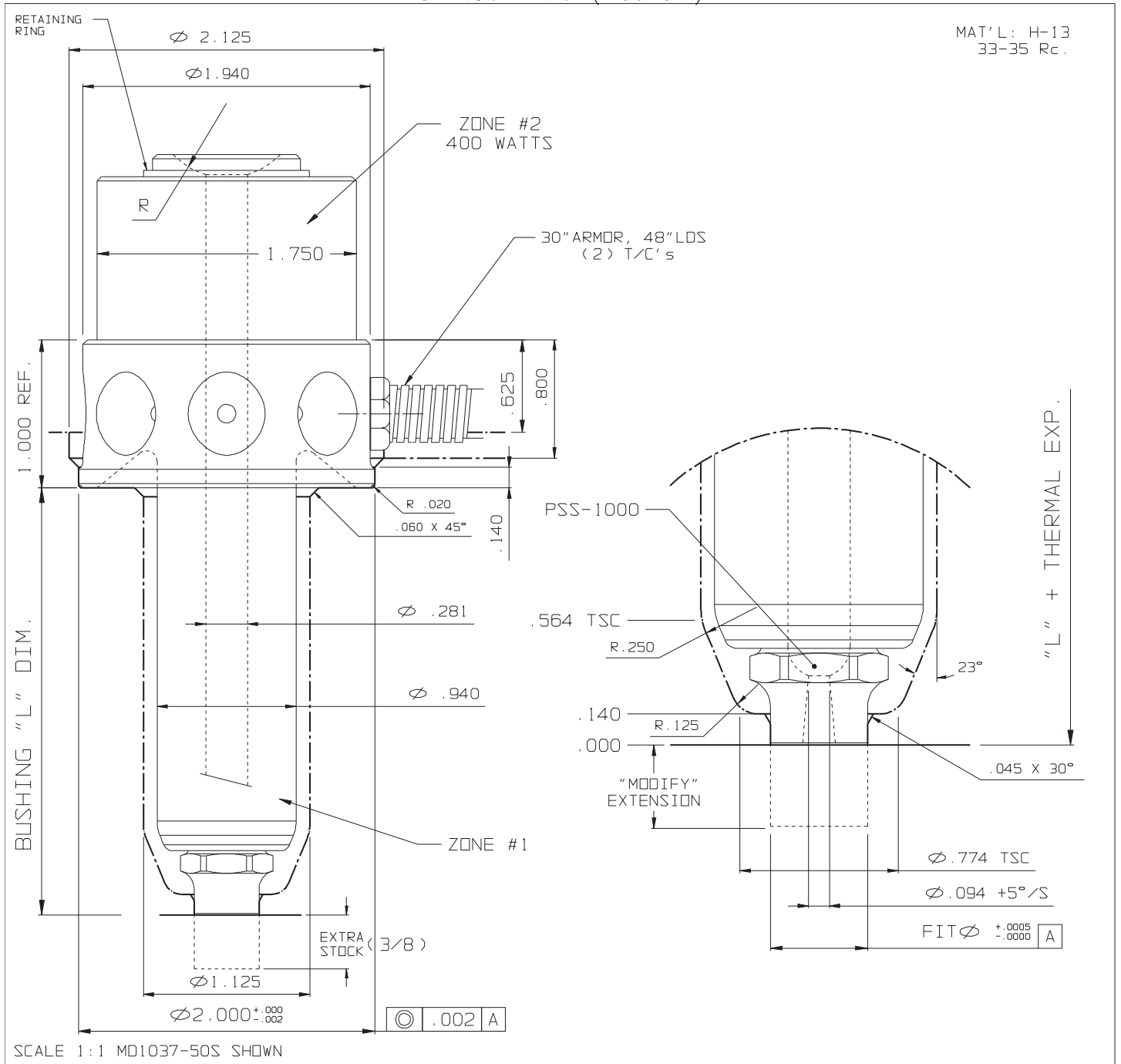

BUSHING # (220V)					THERMAL EXPANSION ΔL @ (°F)				OPTIONS		
L	½" SPH. RAD.	¾" SPH. RAD.	WATTS	T/C	370°F	460°F	550°F	640°F	END CAPS		
1.375	MD1023-50S	MD1023-75S	645	J2-06	0.004	0.006	0.007	0.009	STANDARD	EXTRA STOCK	FIT Ø
1.875	MD1027-50S	MD1027-75S	665	J2-06	0.005	0.007	0.009	0.011	PSS-1000	PSS-1000ES	.4375
2.375	MD1033-50S	MD1033-75S	695	J2-10	0.006	0.009	0.011	0.013	MDS-1000	MDS-1000ES	1.000
2.875	MD1037-50S	MD1037-75S	740	J2-10	0.007	0.010	0.012	0.015	GATE Ø		
3.375	MD1043-50S	MD1043-75S	760	J2-10	0.008	0.011	0.014	0.016	.094-.156	NONE	N/A
3.875	MD1047-50S	MD1047-75S	785	J2-10	0.009	0.013	0.016	0.018			
4.375	MD1053-50S	MD1053-75S	810	J2-10	0.010	0.014	0.017	0.020			
4.875	MD1057-50S	MD1057-75S	835	J2-10	0.011	0.015	0.019	0.022			
5.375	MD1063-50S	MD1063-75S	860	J2-10	0.012	0.017	0.020	0.024			